

FOR THE HARSHTEST CONDITIONS – THE HEAVY-DUTY LINEAR ENCODER



The image shows a diagram of measuring elements at the top left, consisting of a series of magnets with arrows indicating their orientation. Below this are two long, silver-colored linear encoders. The top one is labeled 'SICK POMUX' and has a multi-pin connector. The bottom one is also labeled 'SICK POMUX' and has a single-pin connector.



The logos for PROFIBUS, SSI, and POMUX are displayed. PROFIBUS is in blue and red, SSI is in black, and POMUX is in black with a registered trademark symbol.

Additional information

Detailed technical data J-645
 Ordering information J-647
 Dimensional drawings J-651
 Pin assignment J-652
 Implementation J-654
 Switch settings J-655
 General information J-655
 Position tolerance J-655
 Recommended accessories J-656

Product description

The POMUX KH53 non-contact linear encoder can measure absolute lengths up to 1,700 m. The encoder consists of two main components: The non-contact read head determines the absolute position using a series of measuring elements attached along the measurement path. Each measuring element consists of a number of permanent magnets. Since the distances between the magnets are unique, they can be used to develop an absolute measuring code. No reference

run is required due to the absolute position being determined. The read head is passed parallel to these measuring elements at a distance of 25 mm or 55 mm. With a measuring length of up to 1,700 m, the KH53 is ideal for use in cranes, in storage and conveyor systems, and for railed vehicles. Due to the non-contact technology, this system works wear-free even in harsh ambient conditions, so that a long lifetime is ensured.

At a glance

- Non-contact length measurement – maintenance-free, rugged, long service life
- High reproducibility (0.3 mm / 1 mm), high system resolution (0.1 mm)
- SSI and PROFIBUS interfaces
- Determination of absolute position
- Measuring lengths of up to 1,700 m possible
- Can be used in the harshest ambient conditions
- High traversing speeds of up to 6.6 m/s
- Distance tolerance between read head and measuring element: up to 55 mm ± 20 mm possible

Your benefits

- After installation, the system is immediately available and completely maintenance-free, which leads to time and cost savings
- Reliable determination of position under harshest ambient conditions such as the effects of dirt, dust, fog, shock, and vibration
- High efficiency and productivity levels
- Time savings – no reference run necessary on initial commissioning due to absolute position measurement
- Accurate positioning even with high mounting tolerances



Fields of application

- Position determination for container cranes in container terminals
- Positioning of the trolley on cranes
- Positioning of automated guided vehicles in storage and conveyor systems

Detailed technical data

Performance

	KH53	KH53 Advanced
Measuring length	0 m ... 1,700 m	0 m ... 548 m
Measuring range	38 m, 107 m, 354 m, 1,700 m	54 m, 548 m
Interfaces	SSI and PROFIBUS	
Resolution	0.1 mm	
Reproducibility	0.3 mm	1 mm
Max. traversing speed ¹⁾	6.6 m/s	
Measurement accuracy ²⁾	$\pm 1000 + ME (Tu -25 \text{ }^\circ\text{C}) T_k \mu\text{m}$	$\pm 2000 + ME (Tu -25 \text{ }^\circ\text{C}) T_k \mu\text{m}$

¹⁾ An error message appears if the max. traversing speed is exceeded or the read head cannot detect a measuring element (with SSI FF FF FE hex).

²⁾ Related to the start of a measuring element if a position tolerance of ± 1 mm is maintained based on the nominal distance in the N and Y directions. ME = Length of the measuring element (see illustration on page J-652), Tu = ambient temperature in °C, Tk = coefficient of thermal expansion (see "Mechanical Data" table on page J-646).

Electrical data

Initialization time	2 s	
Position forming time	SSI	0.8 ms
	PROFIBUS	1.1 ms
Supply voltage	10 ... 32 V	
Electrical connection	SSI	Cable M23 male connector
	PROFIBUS	3 x M12 male connectors
SSI		
RS422 interface for parameterizing	Four wire transmission, asynchronous, full-duplex Data format: 1 start bit, 8 data bits, 1 stop bit, no parity Data protocol: ASCII, Baud rate 9,600	
Interface digital, serial	SSI 24 bit, gray	
Default setting SSI standard	RS 422 OFF	
SSI power consumption	250 mA	
PROFIBUS DP		
Electrical interface	RS485 (as per EN 50 170-2 (DIN 19245 Parts 1–3) electrically isolated by optocoupler	
Address setting (node number)	0 ... 127 (hex switch or protocol)	
Protocol	PROFIBUS DP basic functions (DP-V0)	
Bus termination	Via external male connectors	
SET (electronic adjustment)	Via protocol	
Encoder profile	Profiles for encoders (07hex) – Class 2	
Data transmission rate (baud rate)	9.6 kBaud ...12 Mbaud (autodetect)	
Status information	Operation (LED green), bus activity (LED red)	
PROFIBUS power consumption in operation	2.5 W	

¹⁾ According to ISO13849. This product is a standard product and does not constitute a safety component as defined in the Machinery Directive. Calculation based on nominal load of components, average ambient temperature of 40 °C, frequency of use 8760 h/a. All electronic failures are considered hazardous. For more information, see document no. 8015532.

MTTFd: mean time to dangerous failure			
SSI	Measuring range up to 38 m:	45 years ¹⁾	Measuring range up to 54 m: 34 years ¹⁾ Measuring range up to 548 m: 22 years ¹⁾
	Measuring range up to 107 m:	40 years ¹⁾	
	Measuring range up to 354 m:	31 years ¹⁾	
	Measuring range up to 1,700 m:	21 years ¹⁾	
PROFIBUS	Measuring range up to 38 m:	40 years ¹⁾	Measuring range up to 54 m: 30 years ¹⁾ Measuring range up to 548 m: 20 years ¹⁾
	Measuring range up to 107 m:	35 years ¹⁾	
	Measuring range up to 354 m:	28 years ¹⁾	
	Measuring range up to 1,700 m:	20 years ¹⁾	

¹⁾ According to ISO13849. This product is a standard product and does not constitute a safety component as defined in the Machinery Directive. Calculation based on nominal load of components, average ambient temperature of 40 °C, frequency of use 8760 h/a. All electronic failures are considered hazardous. For more information, see document no. 8015532.

Mechanical data

	KH53	KH53 Advanced
Mass		
Read head 38	2.4 kg	-
Read head 107	2.7 kg	-
Read head 354	3.6 kg	-
Read head 1,700	5.2 kg	-
Read head 54	-	4.4 kg
Read head 548	-	6.7 kg
Measuring element	0.5 kg/m	0.65 kg/m
Length of measuring element	See tables on Page J-647 and Page J-649	
Coefficient of thermal expansion	28 µm/°C/m	
Position tolerance (see diagram on Page J-655)	± 10 mm	± 20 mm
Read head material	AlMgSiPbF28	
Measuring element material	AlMgSiO,5F22	

Ambient data

EMC ¹⁾	According to EN 61000-6-2 and EN 61000-6-4	
Enclosure rating		
SSI read head with cable	IP 66	
SSI read head with screw-in system	IP 65 (with mating connector fitted)	
Read head with PROFIBUS connectors	IP 67 (with mating connector fitted)	
Operating temperature range	-20 ... +60 °C	-30 ... +70 °C
Read head storage temperature range	-40 ... +85 °C	
Resistance to shocks	According to EN 61000-2-27	
Read head	30 g/10 ms	
Measuring element	50 g / 10 ms	
Resistance to vibrations	According to DIN EN 61000-2-6	
Read head	10 g/20 ... 250 Hz	
Measuring element	30 g / 20 ... 250 Hz	

¹⁾ The EMC according to the standards quoted is achieved if shielded connecting cables are used.



SSI ordering information

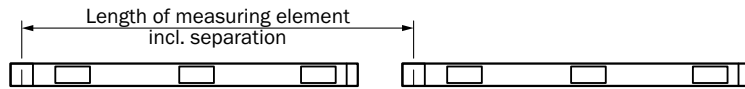

Dimensions and calculation table - KH53

Measuring range up to	Read head length	Length of measuring element including distance	Mounting systems per measuring element (suggestion)
39.90 m	0.886 m	2.304 m Identification letters A1 ... ≤ A18	4 clamp holders or 8 mounting brackets
107.40 m	1.051 m	1.8688 m Identification letters B1 ... ≤ B58	3 clamp holders or 6 mounting brackets
351.20 m	1.376 m	2.5088 m Identification letters C1 ... ≤ C141	4 clamp holders or 8 mounting brackets
1676.40 m	2.026 m	1.9072 m Identification letters D1 ... ≤ D880	3 clamp holders or 6 mounting brackets

The dimensions given are slightly rounded.

Measurement and calculation table - KH53 Advanced

Measuring range up to	Read head length	Length of measuring element including distance	Mounting systems per measuring element (suggestion)
53.50 m	1.58 m	1.408 m Identification letters F1 ... ≤ F39	3 clamp holders or 6 mounting brackets
546.40 m	2.506 m	2.3552 m Identification letters G1 ... ≤ G233	4 clamp holders or 8 mounting brackets

The dimensions given are slightly rounded.

Calculation example for a measurement distance of 100 m

Selected system with measuring range up to 107 m

Number of measuring elements required = measurement path + length of the read head / length of measurement element (according to table above)

Number of measuring elements required = 101.051 m / 1.8688 m = 54.07

Ordering amount therefore **55 measuring elements** and **55 * 3 = 165 clamp holders**

If **two separate measurement paths** are to be implemented, then please order **2 x 55** measuring elements (**not 110** measuring elements)

Attention! For position determination, the read head must not travel beyond the last measuring element.

KH53 length measurement systems (absolute, linear)

Measuring range up to 38 meters

Description	Type	Part no.
Read head 38, SSI, cable 1.5 m	KHK53-AXR00038	1030048
Read head 38, SSI, cable 3.0 m	KHK53-AXS00038	1030049
Read head 38, SSI, cable 5.0 m	KHK53-AXT00038	1030050
Read head 38, SSI, cable 10.0 m	KHK53-AXU00038	1030051
Read head 38, SSI, M23 male, 12 pin	KHK53-AXB00038	1030052
Measuring element up to 38 m, coded ¹⁾	KHT53-XXX00038	1030055
Measuring element up to 38 m, universally codeable ²⁾	KHU53-XXX00038	1030056
Assembly gauge 38	KHM53-XXX00038	1030057

¹⁾ When ordering replacements for individual defective measuring elements, please enter the code for the measuring element in question .

²⁾ For the temporary replacement of defective, coded measuring elements.

Measuring range up to 107 meters

Description	Type	Part no.
Read head 107, SSI, cable 1.5 m	KHK53-AXR00107	1030058
Read head 107, SSI, cable 3.0 m	KHK53-AXS00107	1030059
Read head 107, SSI, cable 5.0 m	KHK53-AXT00107	1030060
Read head 107, SSI, cable 10.0 m	KHK53-AXU00107	1030061
Read head 107, SSI, M23 male device connector, 12 pin	KHK53-AXB00107	1030062
Measuring element up to 107 m, coded ¹⁾	KHT53-XXX00107	1030065
Measuring element up to 107 m, universally codeable ²⁾	KHU53-XXX00107	1030066
Assembly gauge 107	KHM53-XXX00107	1030067

¹⁾ When ordering replacements for individual defective measuring elements, please enter the code for the measuring element in question .

²⁾ For the temporary replacement of defective, coded measuring elements.

Measuring range up to 354 meters

Description	Type	Part no.
Read head 354, SSI, cable 1.5 m	KHK53-AXR00107	1030068
Read head 354, SSI, cable 3.0 m	KHK53-AXS00354	1030069
Read head 354, SSI, cable 5.0 m	KHK53-AXT00354	1030070
Read head 354, SSI, cable 10.0 m	KHK53-AXU00354	1030071
Read head 354, SSI, M23 male device connector, 12 pin	KHK53-AXB00354	1030072
Measuring element up to 354 m, coded ¹⁾	KHT53-XXX00354	1030075
Measuring element up to 354 m, universally codeable ²⁾	KHU53-XXX00354	1030076
Assembly gauge 354	KHM53-XXX00354	1030077

¹⁾ When ordering replacements for individual defective measuring elements, please enter the code for the measuring element in question .

²⁾ For the temporary replacement of defective, coded measuring elements.

Measuring range up to 1,700 meters

Description	Type	Part no.
Read head 1700, SSI, cable 1.5 m	KHK53-AXR01700	1030078
Read head 1700, SSI, cable 3.0 m	KHK53-AXS01700	1030079
Read head 1700, SSI, cable 5.0 m	KHK53-AXT01700	1030080
Read head 1700, SSI, cable 10.0 m	KHK53-AXU01700	1030081
Read head 1700, SSI, M23 male device connector, 12 pin	KHK53-AXB01700	1030082
Measuring element up to 1,700 m, coded ¹⁾	KHT53-XXX01700	1030085
Measuring element up to 1,700 m, universally codeable ²⁾	KHU53-XXX01700	1030086
Assembly gauge 1700	KHM53-XXX01700	1030087

¹⁾ When ordering replacements for individual defective measuring elements, please enter the code for the measuring element in question .

²⁾ For the temporary replacement of defective, coded measuring elements.



KH53 advanced length measurement systems (absolute, linear)

Measuring range up to 54 meters

Description	Type	Part no.
Read head 54, SSI, cable 5.0 m	KHK53-AXT00054	1035442
Read head 54, SSI, M23 male device connector, 12 pin	KHK53-AXB00054	1035443
Measuring element up to 54 m, coded ¹⁾	KHT53-XXX00054	1035445
Measuring element up to 54 m, universally codeable ²⁾	KHU53-XXX00054	1035446
Assembly gauge 54	KHM53-XXX00054	1035447

¹⁾ When ordering replacements for individual defective measuring elements, please enter the code for the measuring element in question .

²⁾ For the temporary replacement of defective, coded measuring elements.

Measuring range up to 548 meters

Description	Type	Part no.
Read head 548, SSI, cable 5.0 m	KHK53-AXT00548	1035448
Read head 548, SSI, M23 male device connector, 12 pin	KHK53-AXB00548	1035449
Measuring element up to 548 m, coded ¹⁾	KHT53-XXX00548	1035451
Measuring element up to 548 m, universally codeable ²⁾	KHU53-XXX00548	1035452
Assembly gauge 548	KHM53-XXX00548	1035453

¹⁾ When ordering replacements for individual defective measuring elements, please enter the code for the measuring element in question .

²⁾ For the temporary replacement of defective, coded measuring elements.

PROFIBUS ordering information

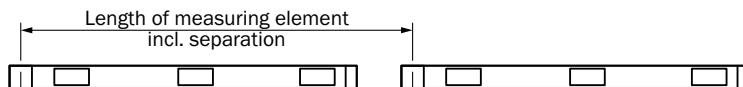

Dimensions and calculation table - KH53

Measuring range up to	Read head length	Length of measuring element including distance	Mounting systems per measuring element (suggestion)
39.90 m	0.905 m	2.304 m Identification letters A1 ... ≤ A18	4 clamp holders or 8 mounting brackets
107.40 m	1.070 m	1.8688 m Identification letters B1 ... ≤ B58	3 clamp holders or 6 mounting brackets
351.20 m	1.395 m	2.5088 m Identification letters C1 ... ≤ C141	4 clamp holders or 8 mounting brackets
1676.40 m	2.045 m	1.9072 m Identification letters D1 ... ≤ D880	3 clamp holders or 6 mounting brackets

The dimensions given are slightly rounded.

Measurement and calculation table - KH53 Advanced

Measuring range up to	Read head length	Length of measuring element including distance	Mounting systems per measuring element (suggestion)
53.50 m	1.599 m	1.408 m Identification letters F1 ... ≤ F39	3 clamp holders or 6 mounting brackets
546.40 m	2.525 m	2.3552 m Identification letters G1 ... ≤ G233	4 clamp holders or 8 mounting brackets

The dimensions given are slightly rounded.

Calculation example for a measurement distance of 100 m

Selected system with measuring range up to 107 m

Number of measuring elements required = measurement path + length of the read head / length of measurement element (according to table above)
Number of measuring elements required = 101.070 m / 1.8688 m = 54.08
Ordering amount therefore 55 measuring elements and 55 * 3 = 165 clamp holders
If two separate measurement paths are to be implemented, then please order 2 x 55 measuring elements (not 110 measuring elements)
Attention! For position determination, the read head must not travel beyond the last measuring element.

KH53 length measurement systems (absolute, linear)

Measuring range up to 38 meters

Description	Type	Part no.
Read head 38, PROFIBUS DP	KHK53-PXF00038	1036163
Measuring element up to 38 m, coded ¹⁾	KHT53-XXX00038	1030055
Measuring element up to 38 m, universally codeable ²⁾	KHU53-XXX00038	1030056
Assembly gauge 38	KHM53-XXX00038	1030057

¹⁾ When ordering replacements for individual defective measuring elements, please enter the code for the measuring element in question .

²⁾ For the temporary replacement of defective, coded measuring elements.

Measuring range up to 107 meters

Description	Type	Part no.
Read head 107, PROFIBUS DP	KHK53-PXF00107	1036164
Measuring element up to 107 m, coded ¹⁾	KHT53-XXX00107	1030065
Measuring element up to 107 m, universally codeable ²⁾	KHU53-XXX00107	1030066
Assembly gauge 107	KHM53-XXX00107	1030067

¹⁾ When ordering replacements for individual defective measuring elements, please enter the code for the measuring element in question .

²⁾ For the temporary replacement of defective, coded measuring elements.

Measuring range up to 354 meters

Description	Type	Part no.
Read head 354, PROFIBUS DP	KHK53-PXF00354	1036165
Measuring element up to 354 m, coded ¹⁾	KHT53-XXX00354	1030075
Measuring element up to 354 m, universally codeable ²⁾	KHU53-XXX00354	1030076
Assembly gauge 354	KHM53-XXX00354	1030077

¹⁾ When ordering replacements for individual defective measuring elements, please enter the code for the measuring element in question .

²⁾ For the temporary replacement of defective, coded measuring elements.

Measuring range up to 1,700 meters

Description	Type	Part no.
Read head 1700, PROFIBUS DP	KHK53-PXF01700	1036166
Measuring element up to 1,700 m, coded ¹⁾	KHT53-XXX01700	1030085
Measuring element up to 1,700 m, universally codeable ²⁾	KHU53-XXX01700	1030086
Assembly gauge 1700	KHM53-XXX01700	1030087

¹⁾ When ordering replacements for individual defective measuring elements, please enter the code for the measuring element in question .

²⁾ For the temporary replacement of defective, coded measuring elements.

KH53 advanced length measurement systems (absolute, linear)

Measuring range up to 54 meters

Description	Type	Part no.
Read head 54, PROFIBUS DP	KHK53-PXF00054	1036167
Measuring element up to 54 m, coded ¹⁾	KHT53-XXX00054	1035445
Measuring element up to 54 m, universally codeable ²⁾	KHU53-XXX00054	1035446
Assembly gauge 54	KHM53-XXX00054	1035447

¹⁾ When ordering replacements for individual defective measuring elements, please enter the code for the measuring element in question .

²⁾ For the temporary replacement of defective, coded measuring elements.

Measuring range up to 548 meters

Description	Type	Part no.
Read head 548, PROFIBUS DP	KHK53-PXF00548	1036168
Measuring element up to 548 m, coded ¹⁾	KHT53-XXX00548	1035451
Measuring element up to 548 m, universally codeable ²⁾	KHU53-XXX00548	1035452
Assembly gauge 548	KHM53-XXX00548	1035453

¹⁾ When ordering replacements for individual defective measuring elements, please enter the code for the measuring element in question .

²⁾ For the temporary replacement of defective, coded measuring elements.

Dimensional drawing SSI read head (dimensions in mm)

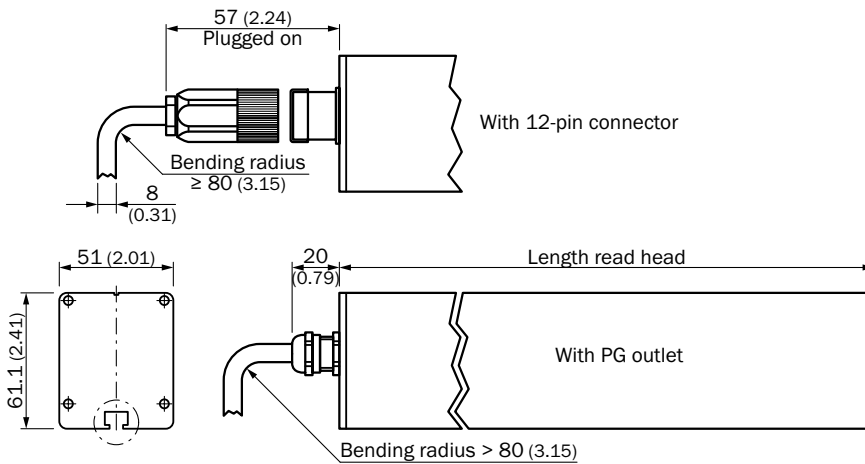

Dimensional drawing PROFIBUS read head (dimensions in mm)

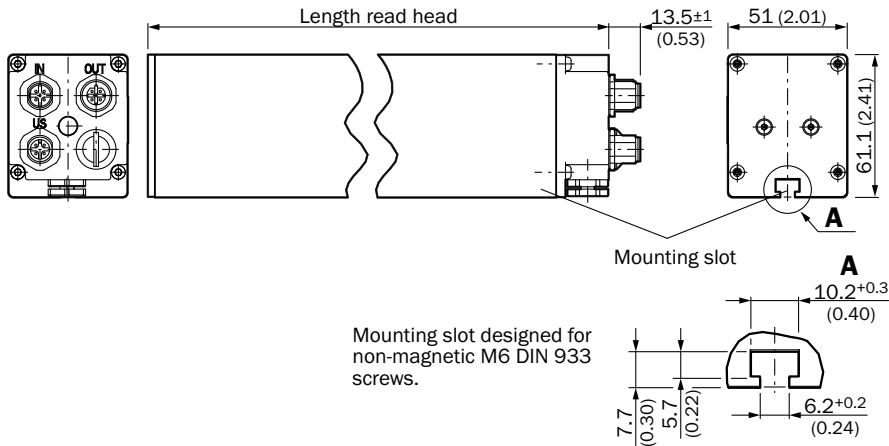

Dimensional drawing for measuring element

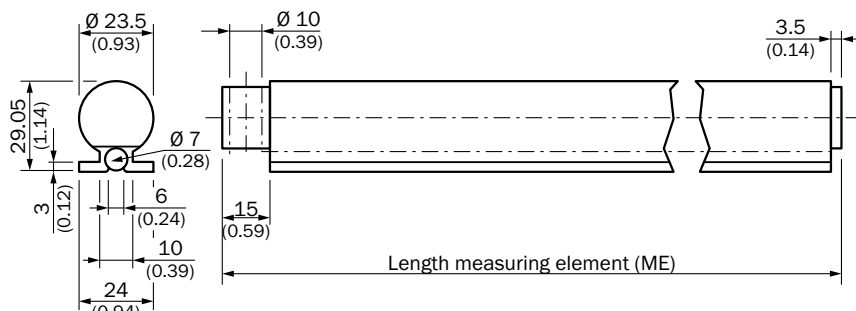

Pin assignment for SSI interface

View of M23 male device connector on SSI encoder

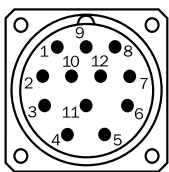

PIN	Signal	Wire colors (cable outlet)	Explanation
1	GND	Blue	Ground connection
2	Data +	White	Interface signals
3	Clock +	Yellow	Interface signals
4	R x D +	Gray	RS-422 programming cables
5	R x D -	Green	RS-422 programming cables
6	T x D +	Pink	RS-422 programming cables
7	T x D -	Black	RS-422 programming cables
8	+ U _s	Red	Operating voltage
9	N. C.	Orange	Not connected
10	Data -	Brown	Interface signals
11	Clock -	Violet	Interface signals
12	N. C.	-	Not connected

N. C. = Not Connected.

Other interfaces on request.



Pin assignment for PROFIBUS interface

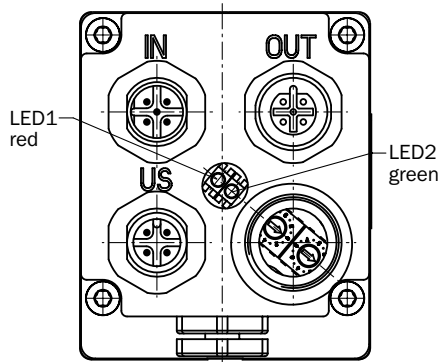

Male connector, 4 pin	Male connector, 5 pin	Female connector 5 pin	Signal	Explanation
1	-	-	U_s (24 V)	Operating voltage 10 ... 32 V
3	-	-	0 V (GND)	Ground (0 V)
-	-	4	B	B cable PROFIBUS DP (out)
-	-	2	A	A cable PROFIBUS DP (out)
-	4	-	B	B cable PROFIBUS DP (in)
-	2	-	A	A cable PROFIBUS DP (in)
-	-	1	2P5 ¹⁾	+ 5 V (potential free)
-	-	3	2M ¹⁾	0 V (potential free)
4	1	-	Not connected	-
2	3	-	Not connected	-
-	5	5	Screen	Housing potential

¹⁾ Use for external bus termination.

Implementation

DP functionalities

according to PROFIBUS-DP basic functionalities.

DP services

- Data exchange (Write_Read_Data)
- Address allocation (Set_Slave_Address)
- Control commands (Global_Control)
- Reading inputs (Read_Inputs)
- Reading outputs (Read_Outputs)
- Reading diagnostic data (Slave_Diagnosis)
- Sending parameter data (Set_Param)
- Checking configuration data (Chk_Config)

Communication

- Cyclic master-slave data traffic.

Safety mechanisms

- Transfer of data with HD = 4.
- Time monitoring of data traffic.

Configuration

Settings according to encoder profile

- Counting direction (CW, CCW)
- Class 2 functionality (ON, OFF)
- Scaling function (ON, OFF)
- “Activation of SSA service”²⁾
- Selection of the station address²⁾

¹⁾ In accordance with encoder profile.

²⁾ Manufacturer specific function.

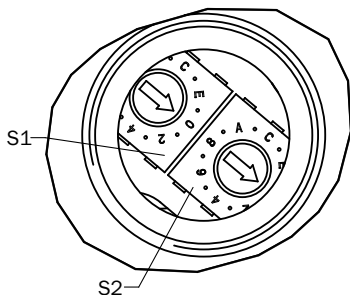

Setting: – Counting direction

- Via hardware via hex switch S2
- Via software via telegram

Count direction increasing:

Movement of the encoder from profile item n in the direction of profile item n+1

Configuration

Setting the formats (IN/OUT) for the cyclic data exchange through a configuration byte (K-1).

2 words IN/OUT data (I-1/O-1)¹⁾

4 words IN/OUT data (I-1, I-2, I-3/O-1)²⁾

Data exchange: – Input data (IN)

I-1 Position value¹⁾ 4 bytes

I-2 Speed (0.1 m/min)²⁾ 2 bytes

I-3 Time stamp²⁾ 2 bytes

Data exchange: – Output data (out)

O-1 PRESET – Value¹⁾ 4 bytes

Diagnostic information

- Station related diagnostic (63 bytes according to encoder profile Class 2)

Setting: – PRESET value

The PRESET function is used for commissioning and the allocation of a particular position value to current physical positioning.

The following settings are possible:

- Via software: – (see Output Data)

Setting: – Station address

- Via hardware via hex switch S1/S2
- Via software via telegram

Setting by software only occurs with prior activation of the “SSA service”.

Device specific file (*.GS_)

The *.GS_ file is designed for automatic commissioning of the encoder. Within it all the characteristic features of the device are defined.

STEG05F6.GSD German

STEG05F6.GSE English

Switch settings

The following settings are possible via hex switches:

- S1/S2 Address setting (0 ... 127)
- S2 Counting direction (CW/CCW)

Access is via a screw connection on the side of the read head male connector.

Status information via LEDs

- LED-1 Bus activity (red)
- LED-2 Operating voltage (green)

General information

The KH53 PROFIBUS is an absolute length measurement system with a resolution of 100 µm. The bus coupling is inside the encoder and is an interface connection as PROFIBUS DP slave according to EN 50170 Vol. 2. Implementation is with the Siemens PROFIBUS ASIC SPC3.

The KH53 PROFIBUS contains all Class 2 functionalities according to the encoder profile (V1.1)

Implementation of the encoder is as a DP slave with the DP basic functions.

Conformity with PROFIBUS DP is ensured by a PNO certified test center.

The following options are available:

- M12 plug connector system

Position tolerances

Start of measurement path

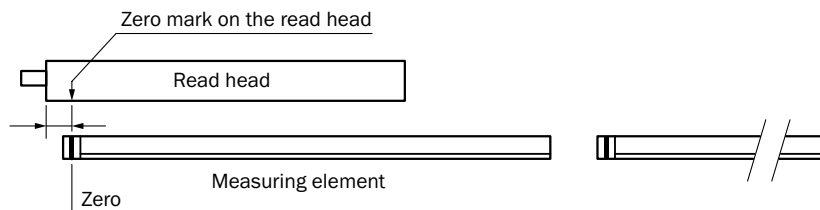

End of measurement path

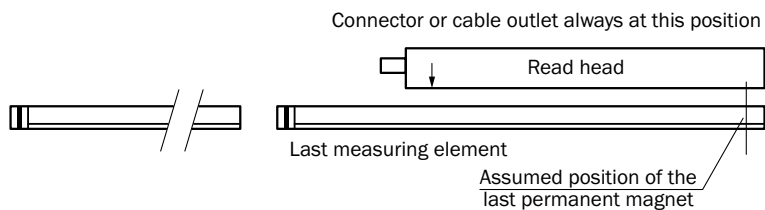

The operating reliability and accuracy of the measuring system depends on (amongst other things) compliance with the position tolerances. Magnetic or magnetizable materials are not permitted within 80 mm of the encoder or the measuring element.

KH53

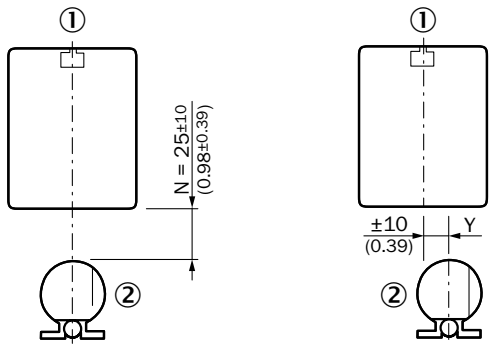

All dimensions in mm (inch)

- ① Read head
- ② Measuring element

KH53 Advanced

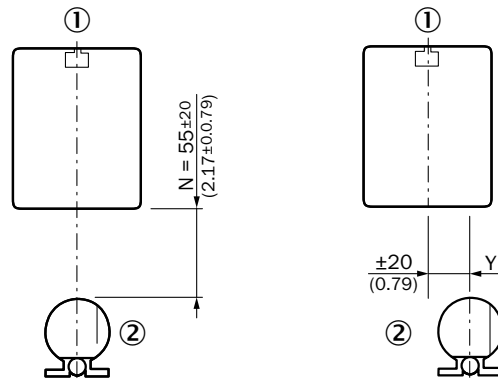

All dimensions in mm (inch)

- ① Read head
- ② Measuring element

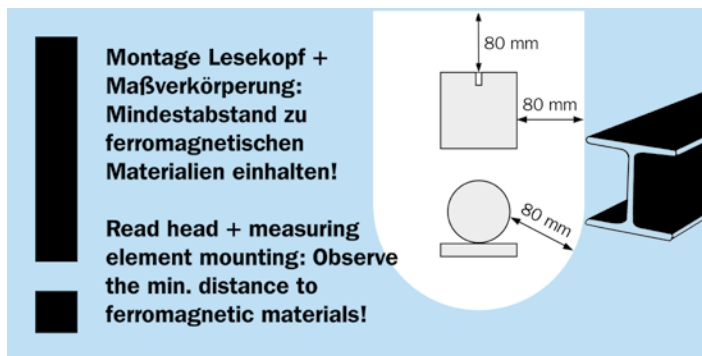

Only use non ferro-magnetic materials for the assembly base of the read head. A separation distance of 80 mm must be observed for ferro-magnetic materials (e.g., iron).

Recommended accessories

Mounting systems

Mounting brackets and plates

Mounting bracket

Figure	Brief description	Type	Part no.
	Mounting bracket for KH53 measuring elements, without mounting hardware for the base	BEF-WK-KHT53	2029159

Clamp and alignment brackets



Terminal brackets

Figure	Brief description	Type	Part no.
	Spacer for KH53 measuring elements, without mounting hardware for the base	BEF-KHA-KHT53	2042468

Connectors

Plug connectors and cables



Connecting cables with female connector

Figure	Brief description	Length of cable	Type	Part no.
	Head A: M12 female connector, 4-pin, straight Head B: cable Cable: for power supply, suitable for drag chain, PVC, unshielded, 4 x 0.25 mm ² , Ø 5.0 mm	5 m	DOL-1204-G05M	6009866
	Head A: M12 female connector, 5-pin, straight Head B: cable Cable: suitable for drag chain, PROFIBUS DP, PUR, halogen-free, shielded, 2 x 0.34 mm ² , Ø 8.0 mm	5 m	DOL-1205-G05MQ	6026006
		10 m	DOL-1205-G10MQ	6026008
	Head A: M23 female connector, 12-pin, straight Head B: cable Cable: SSI, RS-422, suitable for drag chain, PUR, shielded, 4 x 2 x 0.25 mm ² + 2 x 0.5 mm ² + 2 x 0.14 mm ² , Ø 7.8 mm	1.5 m	DOL-2312-G1M5MA1	2029200
		3 m	DOL-2312-G03MMA1	2029201
		5 m	DOL-2312-G05MMA1	2029202
		10 m	DOL-2312-G10MMA1	2029203
		20 m	DOL-2312-G20MMA1	2029204
		30 m	DOL-2312-G30MMA1	2029205

Connecting cables with male connector



Figure	Brief description	Length of cable	Type	Part no.
	Head A: M12 male connector, 5-pin, straight, B-coded Head B: cable Cable: PROFIBUS DP, suitable for drag chain, PUR, halogen-free, shielded, 2 x 0.34 mm ² , Ø 8.0 mm Wire shielding: AL-PT foil, total shield, tin-plated C shield	5 m	STL-1205-G05MQ	6026005
		10 m	STL-1205-G10MQ	6026007
		12 m	STL-1205-G12MQ	6032635

Female connectors (ready to assemble)

Figure	Brief description	Type	Part no.
	Head A: M12 female connector, 4-pin, straight, unshielded, for power supply, for cable diameter 4 mm ... 6 mm Head B: -	DOS-1204-G	6007302
	Head A: M12 female connector, 5-pin, straight, B-coded, PROFIBUS DP, shielded, for cable diameter 4 mm ... 9 mm Head B: -	DOS-1205-GQ	6021353
	Head A: M23 female connector, 12-pin, straight, HIPERFACE®, SSI, incremental, shielded, for cable diameter 5.5 mm ... 10.5 mm Head B: Operating temperature: -20 °C ... +130 °C	DOS-2312-G	6027538





Cables (ready to assemble)

Figure	Brief description	Length of cable	Type	Part no.
	Head A: cable Head B: cable Cable: PROFIBUS DP, suitable for drag chain, PUR, shielded, 2 x 0.25 mm ² , Ø 8.0 mm	By the meter	LTG-2102-MW	6021355
	Head A: cable Head B: cable Cable: SSI, suitable for drag chain, PUR, halogen-free, shielded, 4 x 2 x 0.25 mm ² + 2 x 0.5 mm ² + 2 x 0.14 mm ² , Ø 7.8 mm		LTG-2512-MW	6027531
	Head A: cable Head B: cable Cable: suitable for drag chain, PUR, halogen-free, shielded, UV and saltwater resistant, 4 x 2 x 0.25 mm ² + 2 x 0.5 mm ² + 2 x 0.14 mm ² , Ø 7.8 mm		LTG-2612-MW	6028516

Other plug connectors and cables

Figure	Brief description	Type	Part no.
	Head A: M12 male connector, 4-pin, straight, B-coded Cable: PROFIBUS DP, terminator	STE-END-Q	6021156

Male connector (ready to assemble)

Figure	Brief description	Type	Part no.
	Head A: M12 male connector, 5-pin, straight, B-coded, PROFIBUS DP, shielded, for cable diameter 4 mm ... 9 mm Head B: -	STE-1205-GQ	6021354
	Head A: M23 male connector, 12-pin, straight, HIPERFACE®, SSI, incremental, RS-422, shielded, for cable diameter 5.5 mm ... 10.5 mm Head B: Operating temperature: -20 °C ... +130 °C	STE-2312-G	6027537

Additional accessories

Programming and configuration tools

Figure	Brief description	Type	Part no.
	Programming tool for ATM60, ATM90 and KH53 SSI	PGT-01-S	1030111

→ For additional accessories, please see page K-668 onwards

